



Joytech Products Co., Ltd.

JPWL - 30W12S - 390S2

LED Corn light



General illumination
Outdoor use in outdoor luminaires only (minimum Ip65)
Reduces lumen maintain flux and working life if used
in sealed lamp fixtures. ①

Product features

- Unique structure design, removable power supply and light source (easier for power supply and light source replacement if needed).
- Aluminum fin-shape heat sink and active air exchanges cooling system in order to speed up heat dissipation.
- No UV and near-IR radiation in the light beam.
- The lamp has very low power consumption and low thermal dissipation.
- Not suitable for dimmer, electronic switches and remote control.
- Can easily fit and instead ordinary bulb lights.
- Mainly used in working places, supermarkets and public lighting.

Applications

School

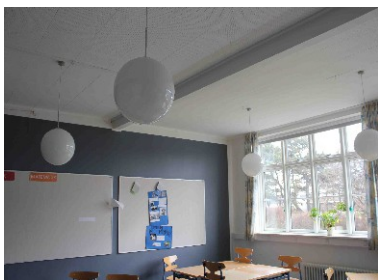

Farm

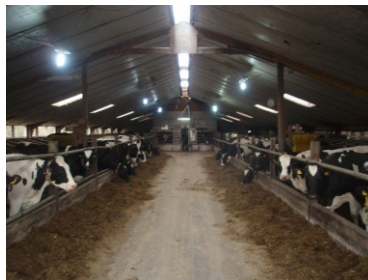

Street



Technical data

Electrical data

Rated wattage	30-40 W
Input Voltage	100-277V AC (AC90-305V is available)
Operating frequency	50/60 Hz
Rated power factor	>0.9
Power Efficiency	>0.87
Humidity	<90%
Ambient temperature	-40~45°C
Base (standard designation)	E26/E27/E39/E40
Replacement conventional lamp power	60W CFL
Dimmable	NO

Light technical data

Light source/count	390pcs. 2835 SMD LED
Luminous flux	3900 Lm
Color temperature	Warm White: 2500 - 3500K Natural White: 4000 - 5000K Cool White: 5500 - 6500K
Color rendering index Ra	Ra > 80
Star ting time	0 sec.
LED emitter life	50000 hrs.
Lifespan of LED lamp	35000 hrs.

Dimension & Weight

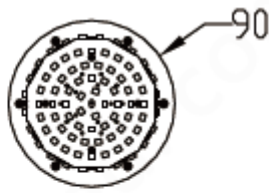
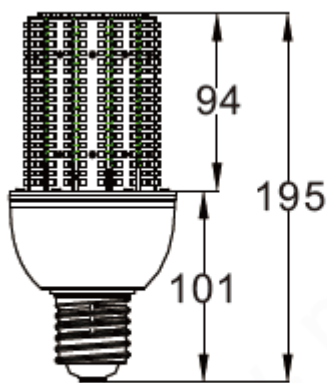

Lamp holder type	E26	E27	E39	E40
Overall length	186mm	188mm	195mm	198mm
Diameter	90mm			
N.W.	365g		390mm	

Logistical Data

Package

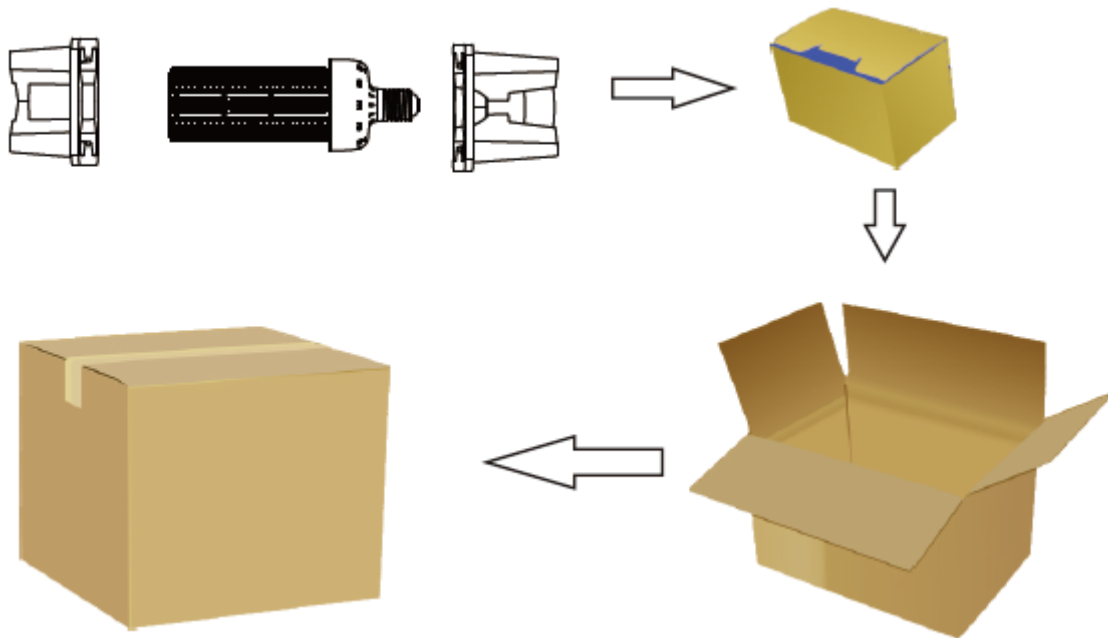

Packaging unit (Pieces/Unit)	Dimensions	Gross weight		Volume
		E26/E27	E39/E40	
Small box	24.5*12.0*12.0cm	E26/E27	E39/E40	0.004m ³
		508g	533g	
Outer carton	50*37*38cm	10.0Kg	10.5Kg	0.07m ³

Installation

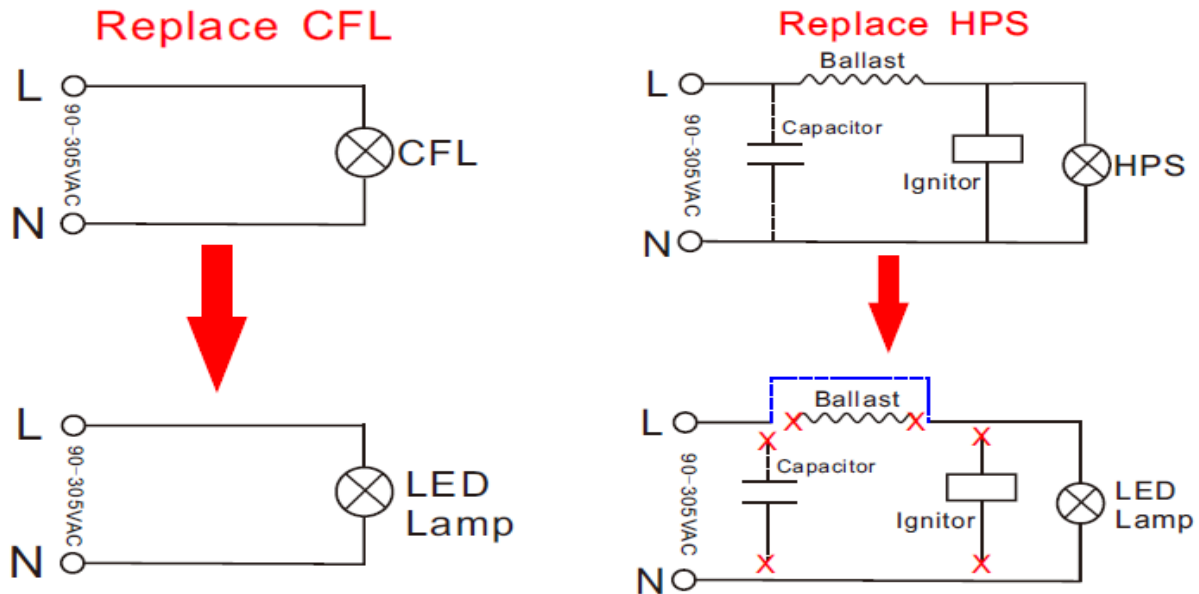

Light Distribution Diagram

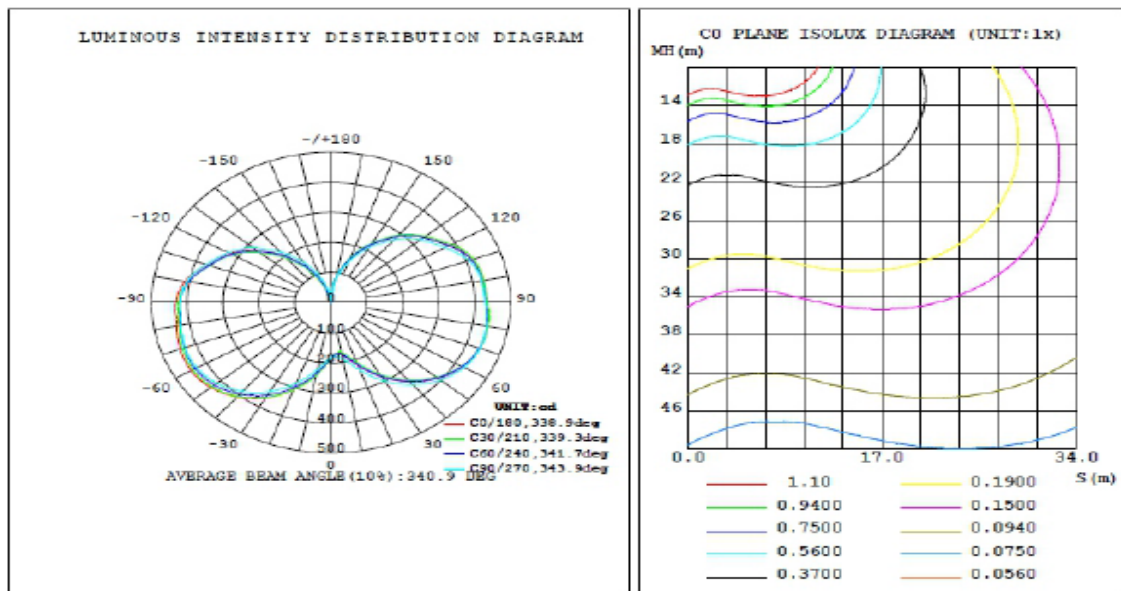

Attention-1

When the products are used in the outdoor lighting, ensure the space is waterproof and well ventilated. Pay attention to the size of the confined space. Ensure the lamp has enough space for heat dissipation which ensures lumen maintenance and extends its working life.

As shown below for your reference

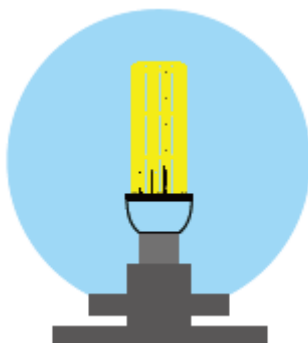

When 30W warehouse light is used in confined space, the diameter must be more than 35cm.

Attention-2

Key benefits of comparison	LED energy saving light 30W	Ectone high lumen twister 60W	Incandescent lamp 220W
Luminous Flux (Lm)	3900	3300	3300
Efficiency (Lm/W)	122	55	15
Better color appearance measured in color rendering index	83	83	98
Wide Color Availability in CCT (Kelvin)	2500-6500	2500-6500	2500
Star ting time, quick start (min)	0	3	0
The life of the lamp (H)	35000	8000	5000

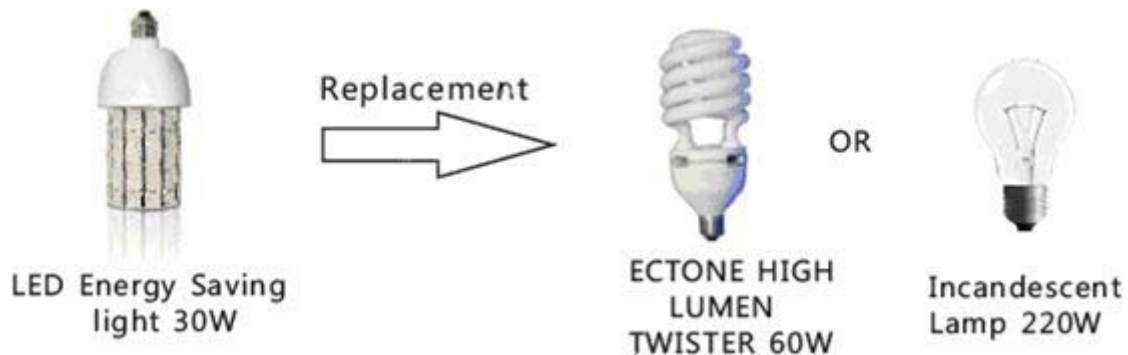

Additional product data

All technical parameters apply to the entire lamp/Due to the complex production process for light-emitting diodes; the typical values shown for the technical LED parameters are purely statistical values that do not necessarily match the actual technical parameters of each individual product, which can vary from the typical value.

Disclaimer

Subject changes without notice except errors and omission. Always make sure to use the most recent release.

JOYTECH PRODUCTS CO., LTD.

1F, No.15, Lane 27, Sec. 3 Chung-king South Rd., Taipei 100, Taiwan, R.O.C.

Tel: 886-2-23582899 Fax: 886-2-23415778

E-Mail: sales@joytech-jpc.com.tw Website: www.joytech-jpc.com.tw